

**BIMHKE**



**HARTMETALL**



ΚΑΤΑΛΟΓΟΣ ΚΟΠΤΙΚΩΝ ΕΡΓΑΛΕΙΩΝ ΠΛΑΣΤΙΚΟΥ &  
AL & METAL CUTTING TOOLS

**METALLOU  
CATALOGUE**



Ειδικά δισκοπρίονα για ελαφρά μέταλλα (NE=μησιδηρούχα υλικά με τραπεζοειδή και επίπεδα δόντια)

 Universal circular saw blades for non-ferrous metals

Part No	D	B	L	d	Z
1050-400-32/50	400	3.2	3.8	32/50	96
1050-420-32	420	3.2	3.8	32	96
1050-450-32	450	3.4	4.0	32	108
1050-502-50	500	3.8	4.4	50	72
• 1050-501-25.4/50	500	3.8	4.4	25.4/50	100
• 1050-500-30/32/50	500	3.5	4.1	30/32/50	100
1050-550-30/32/50	550	3.5	4.1	30/32/50	120
1050-600-50	600	4.4	5.2	50	100

για προφίλ αλουμινίου / for AL profile

Part No	D	B	L	d	Z
1052-250-32	250	2.6	3.2	32	80
1052-260-20	260	2.6	3.2	20	48
1052-300-32	300	2.6	3.2	32	96
1052-350-32	350	2.6	3.2	32	108
1052-400-32	400	3.2	3.8	32	120
1052-420-32	420	3.2	3.8	32	120
1052-450-32	450	3.2	3.8	32	128
• 1052-503-32/50	500	3.8	4.4	32/50	120
• 1052-502-25.4	500	3.8	4.4	25.4	150
• 1052-502-30/32/50	500	3.8	4.4	30/32/50	150
1052-501-30/32/50	500	3.5	4.1	30/32/50	150
1052-500-30/32/50	500	3.5	4.1	30/32/50	120
1052-530-30/32	530	3.8	4.6	30/32	150
• 1052-553-30/32/50	550	3.8	4.4	30/32/50	120
• 1052-552-32/50	550	3.8	4.4	32/50	168
• 1052-554-30	550	3.8	4.4	30	180
1052-550-30/32/50	550	3.5	4.1	30/32/50	168
1052-551-30/32/50	550	3.5	4.1	30/32/50	180
1052-600-50	600	4.4	5.2	50	140
1052-601-60	600	2.8	3.4	60	180
1052-650-50	650	4.4	5.2	50	150

• ειδική παραγγελία

Ειδικά δισκοπρίονα με τραπεζοειδή και επίπεδα δόντια για κοπή προφίλ ή μασίφ αλουμινίου καθώς και για κοπή προφίλ ή μασίφ μη σιδηρούχων μετάλλων

 Universal circular saw blades for non-ferrous metals-negative angle-suitable for cutting aluminum sections or non ferrous metal sections

Part No	D	B	L	d	Z
1054-200-32	200	2.2	2.8	32	48
1054-250-32	250	2.6	3.2	32	60
1054-300-32	300	2.6	3.2	32	72
1054-350-3.2-32	350	2.6	3.2	32	84
1054-351-32	350	2.6	3.2	32	60
1054-370-32	370	3.2	3.8	32	84

για λεπτά προφίλ αλουμινίου / for AL profile

Part No	D	B	L	d	Z
1056-200-32	200	2.2	2.8	32	64
1056-250-30/32	250	2.6	3.2	30/32	80
1056-275-40	275	2.6	3.2	40	88
1056-280-30	280	2.6	3.2	30	90
1056-300-32	300	2.6	3.2	32	96
1056-330-32	330	2.6	3.2	32	102
1056-350-32	350	2.6	3.2	32	108
1056-380-32	380	2.8	3.4	32	110

Ειδικά αθόρυβα δισκοπρίονα για ελαφρά μέταλλα (NE= μη σιδηρούχα υλικά) με τραπεζοειδή και επίπεδα δόντια, για λεπτά προφίλ

 Low noise blades for cutting thin AL profiles

Part No	D	B	L	d	Z
1057-250-32	250	2.6	3.2	32	80
1057-300-32	300	2.6	3.2	32	100
1057-350-32	350	2.6	3.2	32	110

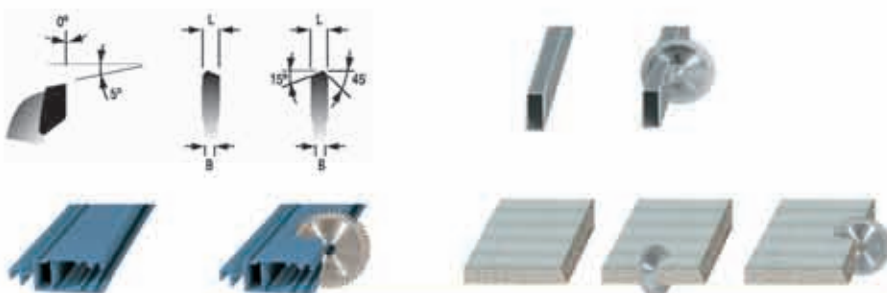

Ειδικά δισκοπρίονα μέταλλου, αλουμινίου, σύνθετα πάνελ αλουμινίου, χαλκού και ορείχαλκου (ST=για ανοξείδωτα)

Περσσότερες διαστάσεις διαθέσιμες κατόπιν παραγγελίας

 Jepson style blades (ST=stainless)  
Additional numbers available upon demand

Part No	D	B	L	d	Z
1058-250-25.4	250	1.8	2.6	25.4	48
1058-305-25.4	305	1.8	2.6	25.4	60
1058-355-2.8-25.4	355	2.0	2.8	25.4	84
1058-250-25.4-ST	250	1.8	2.6	25.4	72
1058-306-25.4-ST	305	1.8	2.6	25.4	80
1058-355-2.8-25.4-ST	355	2.0	2.8	25.4	90

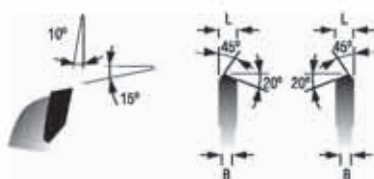

Δισκοπρίονα ειδικής μορφής για κοπή υπο γωνία 45 μοιρών (φαλτσογωνιά)σε κόντρα πλακέ, νοβοπάν, MDF, HF επενδυμένη, πλεξιγκλάς, πλαστικά και κορνίζες



Circular saw blades with special form of the tip for cutting under 45° angle

Part No	D	B	L	d	Z
1111-200-30	200	2.2	3.2	30	64
1111-250-30	250	2.2	3.2	30	80
1111-300-30	300	2.2	3.2	30	96
1111-350-30	350	2.5	3.5	30	108
1111-400-30	400	2.5	3.5	30	120

Part No	D	B	L	d	Z
1112-150-30	150	1.6	2.4	30	48
1112-180-30	180	1.6	2.4	30	58
1112-200-30	200	1.6	2.4	30	64
1112-250-30	250	1.6	2.4	30	80
1112-251-30	250	1.6	2.4	30	100
1112-300-30	300	1.6	2.4	30	96

## ΠΟΤΗΡΟΤΡΥΠΑΝΑ ΜΕΤΑΛΛΟΥ / Holesaw for Cutting Metal



Part No	ΠΕΡΙΓΡΑΦΗ/dimension
5003-ST-28L-16	Φ16x28 HM
5003-ST-28L-19	Φ19x28 HM
5003-ST-28L-22	Φ22x28 HM
5003-ST-28L-25	Φ25x28 HM
5003-ST-28L-29	Φ29x28 HM
5003-ST-28L-30	Φ30x28 HM
5003-ST-28L-33	Φ33x28 HM
5003-ST-28L-35	Φ35x28 HM
5003-ST-28L-38	Φ38x28 HM
5003-ST-28L-40	Φ40x28 HM
5003-ST-28L-42	Φ42x28 HM
5003-ST-28L-44	Φ44x28 HM
5003-ST-28L-46	Φ46x28 HM
5003-ST-28L-48	Φ48x28 HM
5003-ST-28L-50	Φ50x28 HM
5003-ST-28L-54	Φ54x28 HM
5003-ST-28L-56	Φ56x28 HM
5003-ST-28L-60	Φ60x28 HM
5003-ST-28L-64	Φ64x28 HM
5003-ST-28L-70	Φ70x28 HM
5003-ST-28L-75	Φ75x28 HM
5003-ST-28L-79	Φ79x28 HM
5003-ST-28L-85	Φ85x28 HM
5003-ST-28L-90	Φ90x28 HM
5003-ST-28L-95	Φ95x28 HM
5003-ST-28L-100	Φ100x28 HM
5003-ST-40L-20	Φ20x40 HM
5003-ST-40L-25	Φ25x40 HM
5003-ST-40L-30	Φ30x40 HM
5003-ST-40L-35	Φ35x40 HM
5003-ST-40L-40	Φ40x40 HM
5003-ST-40L-45	Φ45x40 HM
5003-ST-40L-50	Φ50x40 HM
5003-ST-40L-55	Φ55x40 HM

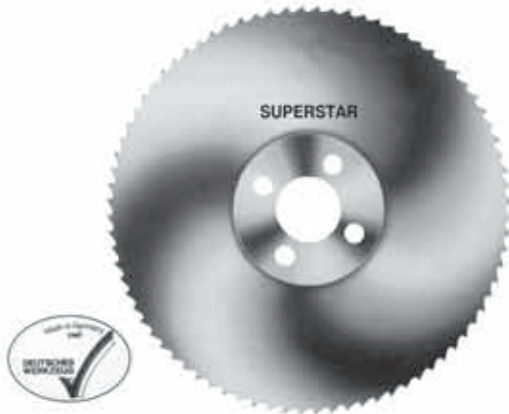

**5050  
HSS DM05**

δίσκοι μετάλλου SUPERSTAR  
HSS circular saw blades

Part No	D	B	d	Z
5050-206	200	1.8	32	130
5050-200	200	1.8	32	160
5050-203	200	2.0	32	160
5050-227	225	1.9	32	140
5050-254	250	1.6	32	128
5050-250	250	2.0	32	200
5050-256	250	2.0	32	160
5050-259	250	2.5	32	128
5050-255	250	3.0	32	200
5050-275	275	2.5	32/40	220
5050-302	300	2.5	32	180
5050-300	300	2.5	32	220
5050-315	315	2.5	32	240
5050-350	350	3.0	32/50	280
5050-355-50	350	3.5	50	280

για μασίφ  
for cutting aluminum sections

Part No	D	B	d	Z
5050-201	200	1.8	32	100
5050-204	200	2.0	32	120
5050-226	225	1.9	32	120
5050-251	250	2.0	32	128
5050-276	275	2.5	32/40	140
5050-301	300	2.5	32	160
5050-316	315	2.5	32	160
5050-351	350	3.0	32	180
5050-352-50	350	3.5	50	180

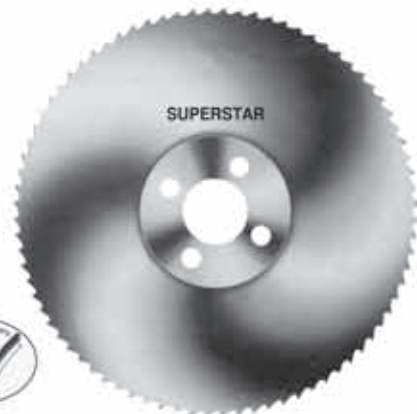

**5051  
HSS C05**

δίσκοι μετάλλου SUPERSTAR  
HSS circular saw blades

Part No	D	B	d	Z
5051-225	225	1.9	32	180
5051-250	250	2.0	32	200
5051-275	275	2.5	32/40	220
5051-300	300	2.5	32	220
5051-315	315	2.5	32	240
5051-317	315	2.5	32	200
5051-350	350	3.0	32/50	280

Part No	D	B	d	Z
5051-226	225	1.9	32	120
5051-251	250	2.0	32	128
5051-276	275	2.5	32/40	140
5051-301	300	2.5	32	160
5051-316	315	2.5	32	160
5051-351	350	3.0	32/50	180

**5054  
HSS DM05 TIN**

δίσκοι μετάλλου SUPERSTAR  
HSS circular saw blades

Part No	D	B	d	Z
5054-200-160-TIN	200	1.8	32	160
5054-200-200-TIN	200	1.5	32	200
5054-200-240-TIN	200	1.2	32	240
5054-250-128-TIN	250	2.0	32	128
5054-250-250-TIN	250	1.5	32	250
5054-250-200-TIN	250	2.0	32	200
5054-250-160-TIN	250	2.0	32	160
5054-275-220-TIN	275	2.5	32	220
5054-300-220-TIN	300	2.5	32	220
5054-300-240-TIN	300	1.6	40	240
5054-315-160-TIN	315	2.5	32	160
5054-350-280-TIN	350	3.0	32	280

Part No	ΠΕΡΙΓΡΑΦΗ / description
6022-019	7011 2x25 ZOT PZ
6022-002	7012 1x25 OTI PZ
6022-003	7012 2x25 OTI PZ
6022-001	7012 3x25 OTI PZ
6022-005	7012 1x25 PZ
6022-006	7012 2x25 PZ
6022-007	7012 3x25 PZ
6022-014	7012 2x25 DURA PZ
6022-008	7012 1x25 INKRA PZ
6022-009	7012 2x25 INKRA PZ
6022-010	7012 3x25 INKRA PZ
6022-011	7012 1x50 ZOT PZ
6022-012	7012 2x50 ZOT PZ
6022-013	7012 3x50 ZOT PZ
6022-018	7048 2x75 ΤΕΤΡΑΓΩΝΗ
6022-016	7048 1x50 ΤΕΤΡΑΓΩΝΗ
6022-015	7048 2x50 ΤΕΤΡΑΓΩΝΗ
6022-017	7048 3x50 ΤΕΤΡΑΓΩΝΗ
6022-051	7149-921S SB ΑΥΤΟΜ.ΤΣΟΚ
6022-052	7113 1/4" S HALTER

PZ



ZOT PZ



ΤΕΤΡΑΓΩΝΗ



ΑΥΤΟΜ. ΤΣΟΚ



S HALTER



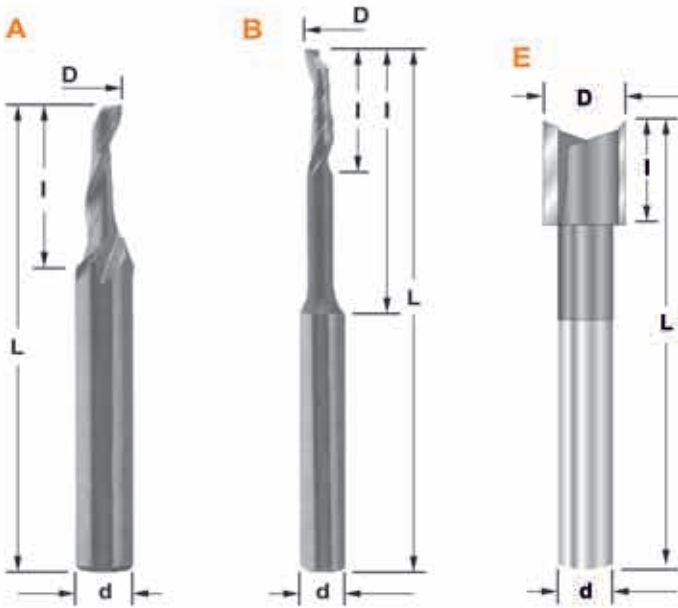

**5105** HSS C05 κοντύλια αλουμινίου / single flute cutters

**A**  
Z1

Part No	D	l	L	d
5105-13	3	12	60	8
5105-01	4	12	60	8
5105-02	5	12	60	8
5105-03	5	14	120	8
5105-04	5	18	60	8
5105-05	6	14	60	8
5105-06	6	14	80	6.35
5105-14	6	14	120	8
5105-07	7	14	60	8
5105-10	10	14	80	10
5105-12	12	14	100	10

**5105** HSS κοντύλια αλουμινίου με ξεθύμασμα / single flute cutters reduced throat for feed clearance

**B**  
Z1

Part No	D	l	L	d
5105-41	5	16/45	80	8
5105-42	5	16/45	90	8
5105-43	5	18/35	80	8
5105-44	6	16/45	90	8
5105-45	6	16/65	90	8
5105-47	8	14/54	80	8
5105-48	8	14/68	100	8
5105-56	8	14/68	100	10
5105-46	8	20/65	120	8
5105-49	6	14/68	100	6.35
5105-50	10	14/70	100	8
5105-51	10	14/70	100	10
5105-53	10	14/95	120	10

**5105** HM κοντύλια αλουμινίου για διαμόρφωση κλειδαριάς / double flute cutters for door key holes

**E**  
Z2

Part No	D	l	L	d
5105-88	10	25	100	10
5105-75	14	25	100	10
5105-76	14	25	100	12
5105-77	16	25	100	12
5105-78	16	25	100	10
5105-54	17.5/10.5		120	10
5105-79	18	25	100	10
5105-80	18	25	100	12
5105-38	19	25	100	10
5105-87	19	25	100	10
5105-81	20	25	100	12
5105-82	20	25	100	10
5105-86	20	25	100	16
5105-55	20	25	120	10

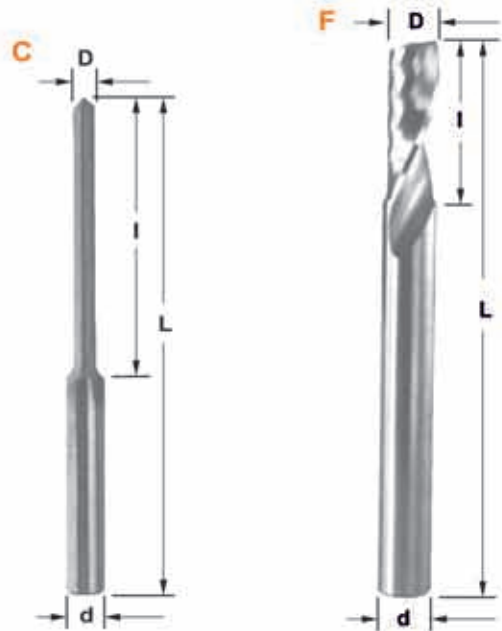

**9-9D** HM κοντύλια ελικοειδή για αλουμίνιο και πλαστικό / solid carbide spiral router for AL and plastic

**F**

Part No	D	l	L	d
9-9D-030	3	12	50	3
9-9D-040	4	12	50	4
9-9D-050	5	15	50	5
9-9D-050A	5	20	60	5
9-9D-060-27-60	6	27	60	6
9-9D-060	6	20	60	6
9-9D-060A-6	6	27	70	6
9-9D-060B-Z2	6	20/55	80	6
9-9D080A	8	32	80	8
9-9D-080.B Z1	8	25/75	100	8
9-9D-080-100-Z2	8	25	100	8
9-9D-10-25	10	25	100	10
9-9D-10-120-Z2	10	25	120	10
9-9D-100B-Z2	10	25	100	10
9-9D-120B	12	52	100	12

**9-9D-310A** γαλισμένα κοντύλια ελικοειδή για αλουμίνιο και πλαστικό / solid carbide spiral router for AL and plastic

**F**  
Z1

Part No	D	l	L	d
9-9D-310A-020	2	6	40	3
9-9D-310A-030	3	12	40	3
9-9D-310A-040	4	15	40	4
9-9D-310A-050	5	16	50	5
9-9D-310A-060	6	20	60	6
9-9D-310A-080	8	25	63	8
9-9D-310A-010	10	25	72	10

**5105** κοντύλια για φελιζόλ / straight flute cutters for felizol

**C**  
Z1

Part No	D	l	L	d
5105-20	5	30	100	8
5105-21	5	45	100	8
5105-22	5	55	100	8



3822								SGLB
ΔΙΑΣΤΑΣΗ / dimension	Z2/3	Z3/4	Z4/6	Z5/7	Z6/10	Z8/12	Z9/11	Z10/14
13x0.65					X	X		X
20x0.90			X		X	X		X
27x0.90		X	X	X	X	X		X
34x1.10	X	X	X	X		X		
41x1.30		X	X					

3823								PROTECTOR
ΔΙΑΣΤΑΣΗ / dimension	Z2/3	Z3/4	Z4/6	Z5/7	Z6/10	Z8/12	Z9/11	Z10/14
27x0.90		X	X	X	X	X		X
34x1.10		X	X					
41x1.30		X	X					

3824								DUOS
ΔΙΑΣΤΑΣΗ / dimension	Z2/3	Z3/4	Z4/6	Z5/7	Z6/10	Z8/12	Z9/11	Z10/14
13x0.65							X	
20x0.90							X	
27x0.90							X	

3825								INOX
ΔΙΑΣΤΑΣΗ / dimension	Z2/3	Z3/4	Z4/6	Z5/7	Z6/10	Z8/12	Z9/11	Z10/14
27x0.90		X	X					
34x1.10		X	X					

3615								INTENSS PRO M42
ΔΙΑΣΤΑΣΗ / dimension	Z2/3	Z3/4	Z4/6	Z5/7	Z6/10	Z8/12	Z10/14	Z14/18
6x0.65							X	
6x0.90								X
10x0.65							X	
13x0.65					X	X	X	X
13x0.90							X	
20x0.90					X	X	X	
27x0.90				X	X	X		

  

3618				για PANEL
ΔΙΑΣΤΑΣΗ/dimension	Z12/16	Z14/18	Z14	Z18
20x0.90	X	X	X	X

κατά τη χρήση της κορδέλας, η επιλογή των δοντιών εξαρτάται πρώτα από το πάχος του υλικού που θέλουμε να κόψουμε και κατόπιν από το ίδιο το υλικό. Προτείνεται κυμαινόμενο δόντι για χαμηλή δόνηση κατά την κοπή προβληματικών και διαφορετικού πάχους υλικών (D/DP)



when employing Bi-metal band saw blades, the choice of teeth first depends on the cross-section of the material being cut and secondly on the material itself. We recommend variable tooth pitch for low-vibration cutting of problematic and / or varying cross-sections of materials being cut (D/DP)

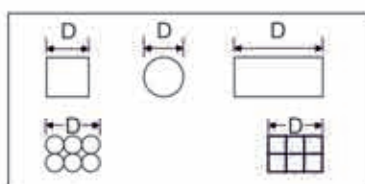

κατεύθυνση κοπής/cutting direction

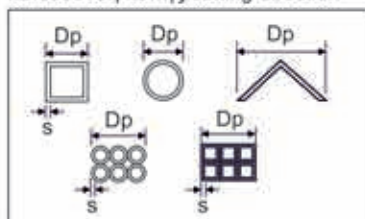

D/DP: πάχος υλικού/  
material cross-section

S: πάχος τοιχώματος υλικού/  
material thickness

για μασίφ / solid material

D(mm)	20	30	50	80	100	200	300	500
Z	10/14	8/12	6/10	5/8	4/6 4/6	3/4	2/3	1/2 0.75/1.25

για σωλήνες και προφίλ / tubes and profiles

Dp(mm)	20	40	60	80	100	120	150	200	300	500	750
S(mm)											
2	14	14	14	14	14	14	10/14	10/14	10/14	8/12	
3	14	14	14	14	10/14	10/14	8/12	6/10	6/10	6/10	
4	14	14	10/14	10/14	8/12	8/12	6/10	6/10	5/8	4/6	
5	14	10/14	10/14	8/12	8/12	6/10	6/10	5/8	4/6	4/6	
8	14	8/12	6/10	6/10	5/8	5/8	5/8	5/8	4/6	4/6	
10		6/10	6/10	5/8	5/8	5/8	4/6	4/6	4/6	3/4	3/4
15				4/6	4/6	4/6	4/6	3/4	3/4	2/3	2/3
20				4/6	3/4	3/4	3/4	3/4	2/3	2/3	2/3
30				3/4	3/4	3/4	3/4	2/3	2/3	2/3	1/2
50				3/4	3/4	3/4	2/3	2/3	2/3	1/2	1/2
80							2/3	1/2	1/2	1/2	1/2
100								1/2		0.75/1.25	0.75/1.25
150										0.75/1.25	0.75/1.25

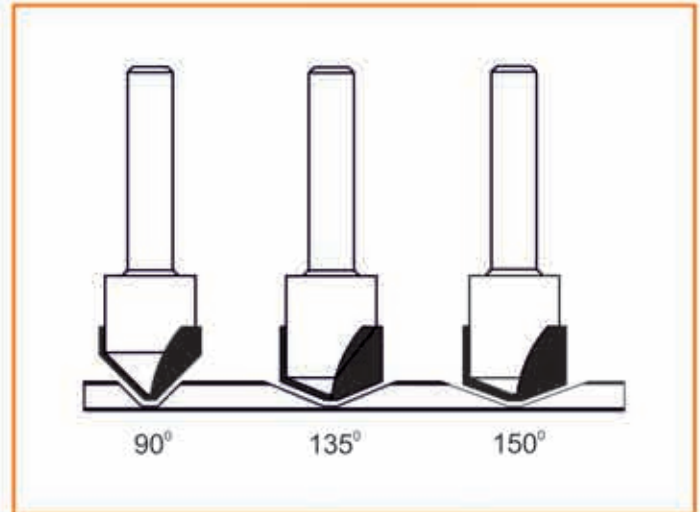
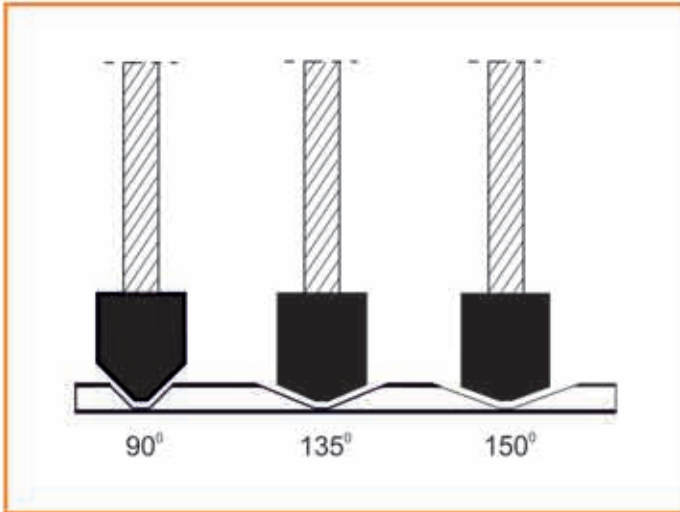

**1200** Δίσκοι ETALBOND-ALUCOBOND  
ETALBOND-ALUCOBOND circular saw blades

Part No	D	d	Z	ΜΟΙΡΕΣ/angle
1200-150	150	30	12	90°
1200-151	150	30	12	135°
1200-180	180	30	12	90°
1200-181	180	30	12	135°
1200-201	200	30	24	90°
1200-202	200	30	24	135°
1200-2441	244	30	24	90°
1200-2442	244	30	24	135°
1200-252	250	30	24	90°
1200-253	250	30	24	135°

**5105** Κοντύλια ETALBOND-ALUCOBOND  
ETALBOND-ALUCOBOND routers

Part No	ΠΕΡΙΓΡΑΦΗ/description
5105-97	ΦΡΕΖΑ ETALBOND 90° d8
5105-98	ΦΡΕΖΑ ETALBOND 135° d8
5105-99	ΦΡΕΖΑ ETALBOND 150° d8

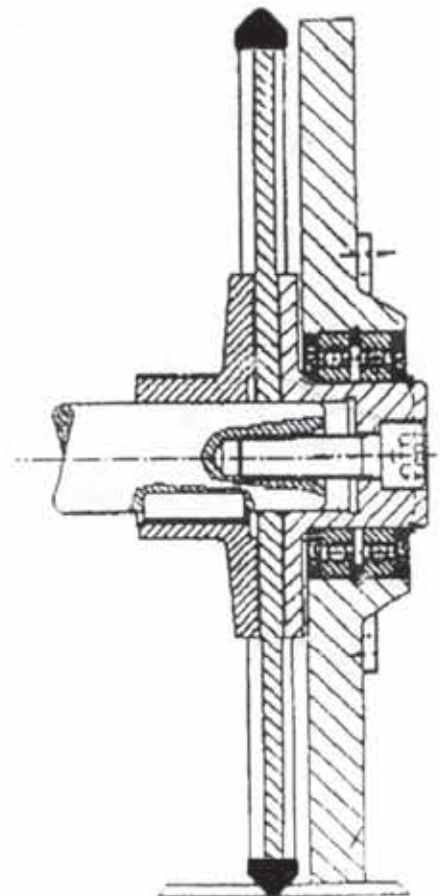
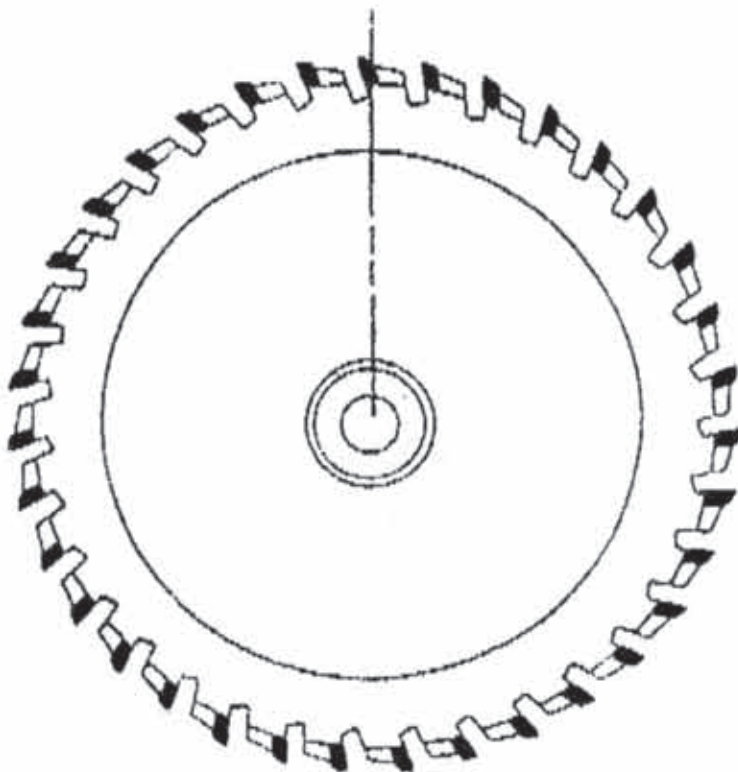

κατασκευή ξελουριστικών όλων των γνωστών σειρών αλουμινίου κατόπιν παραγγελίας / *additional lines are available upon demand*



**ΣΕΙΡΑ 1355 ALUMIL / 1355 ALUMIL LINE**



**ΣΕΙΡΑ 2342 ETEM / 2342 ETEM LINE**



**ΣΕΙΡΑ TV5-546 EUROPA / TV5-546 EUROPA LINE**



**ΣΕΙΡΑ TV5-143 EUROPA / TV5-143 EUROPA LINE**





HARTMETALL

**ΒΙΜΗΚΕ ΑΒΕΕ**

---

**ΚΑΤΑΣΚΕΥΗ & ΕΜΠΟΡΙΑ ΚΟΠΤΙΚΩΝ ΕΡΓΑΛΕΙΩΝ**  
ΕΔΡΑ/ΕΡΓΟΣΤΑΣΙΟ: ΚΡΥΣΤΑΛΛΗ 28, 12131 ΠΕΡΙΣΤΕΡΙ  
ΤΗΛ.: 210 5751920, 210 5751856 - FAX: 210 5762415  
[www.bimike.gr](http://www.bimike.gr) / [info@vimike.gr](mailto:info@vimike.gr)